

ICCVAM Workshop on Best Practices for Regulatory Safety Testing: Ocular Case Studies

January 19, 2011

**Natcher Conference Center, NIH
Bethesda, MD**

Overview

- These ocular case studies are intended to demonstrate
 - Whether a validated and accepted *in vitro* ocular test method should be considered to assess the ocular hazard potential of a test substance
 - Which validated and accepted *in vitro* ocular test method(s) can be used to determine the ocular hazard potential of a test substance
 - The usefulness and limitations of each validated and accepted *in vitro* ocular test method
 - Decision criteria to be used for regulatory hazard classification for *in vitro* ocular test method(s)
 - When it is necessary for a rabbit eye test to be conducted
 - Pain management procedures that should always be used when it is determined necessary to conduct a rabbit eye test
- Based on the information and data provided, you will be asked to assess the potential that a test substance is likely to induce eye injuries

Ocular Case Study 1

Ocular Case Study 1

- You have been asked to assess the potential that a white crystalline powder is likely to induce eye injuries.
- You have been given the following information:
 - The pH of the substance, which is a carboxylic acid = 3.8
 - The substance is insoluble in water.
 - The molecular weight of the substance = 376.33
 - The substance is not a surfactant.
 - Existing animal data do not show corrosive or severe irritant effects on skin.
 - Human accidental exposure data and rabbit eye test data are not available.
 - No additional information is available.

Should a validated and accepted *in vitro* ocular test method be performed?¹

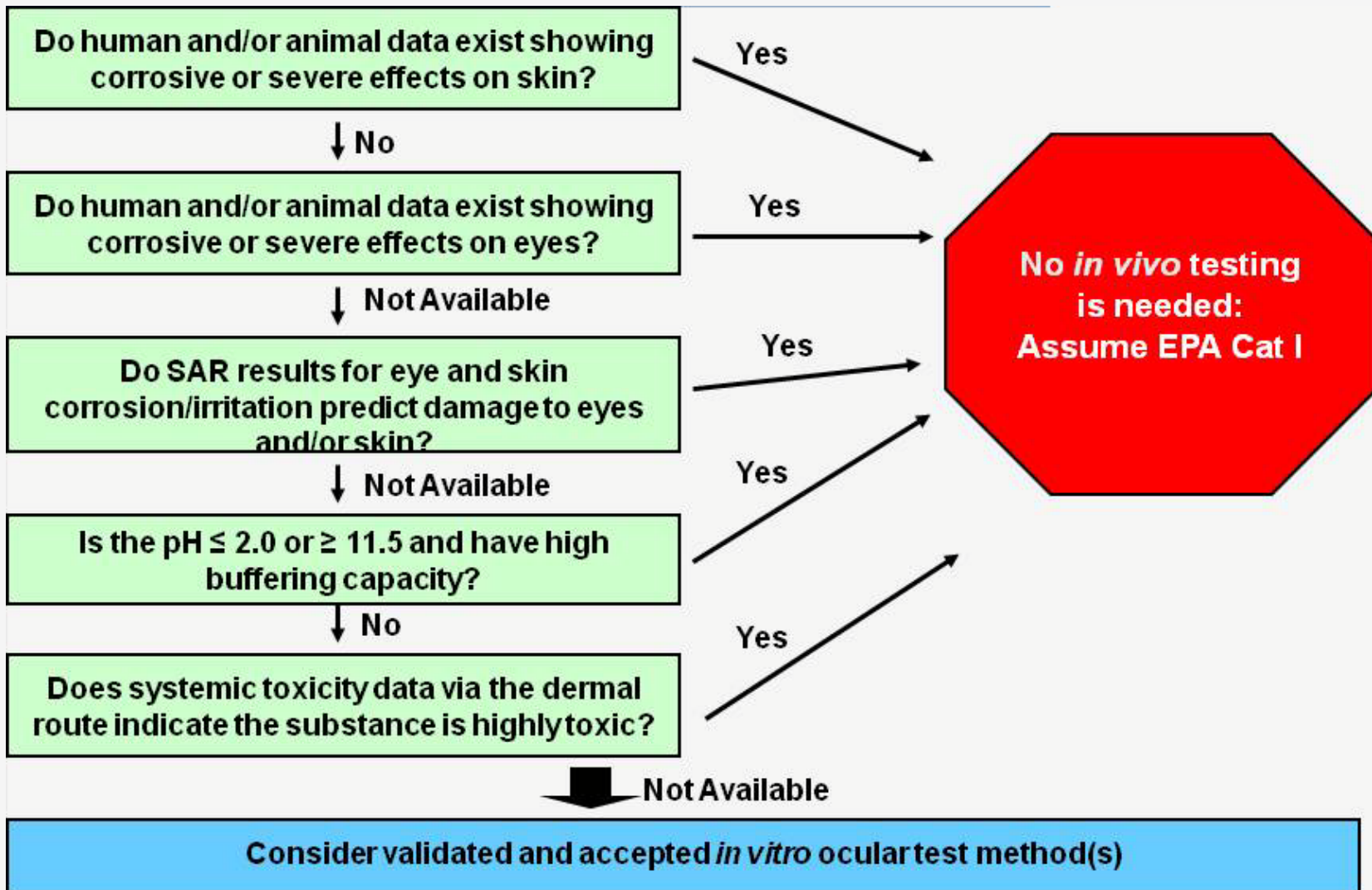

¹Modified from the Testing and Evaluation Strategy for Eye Irritation/Corrosion (TG 405; OECD 2002). ICCVAM



Which *in vitro* ocular test method(s) should be considered for testing?

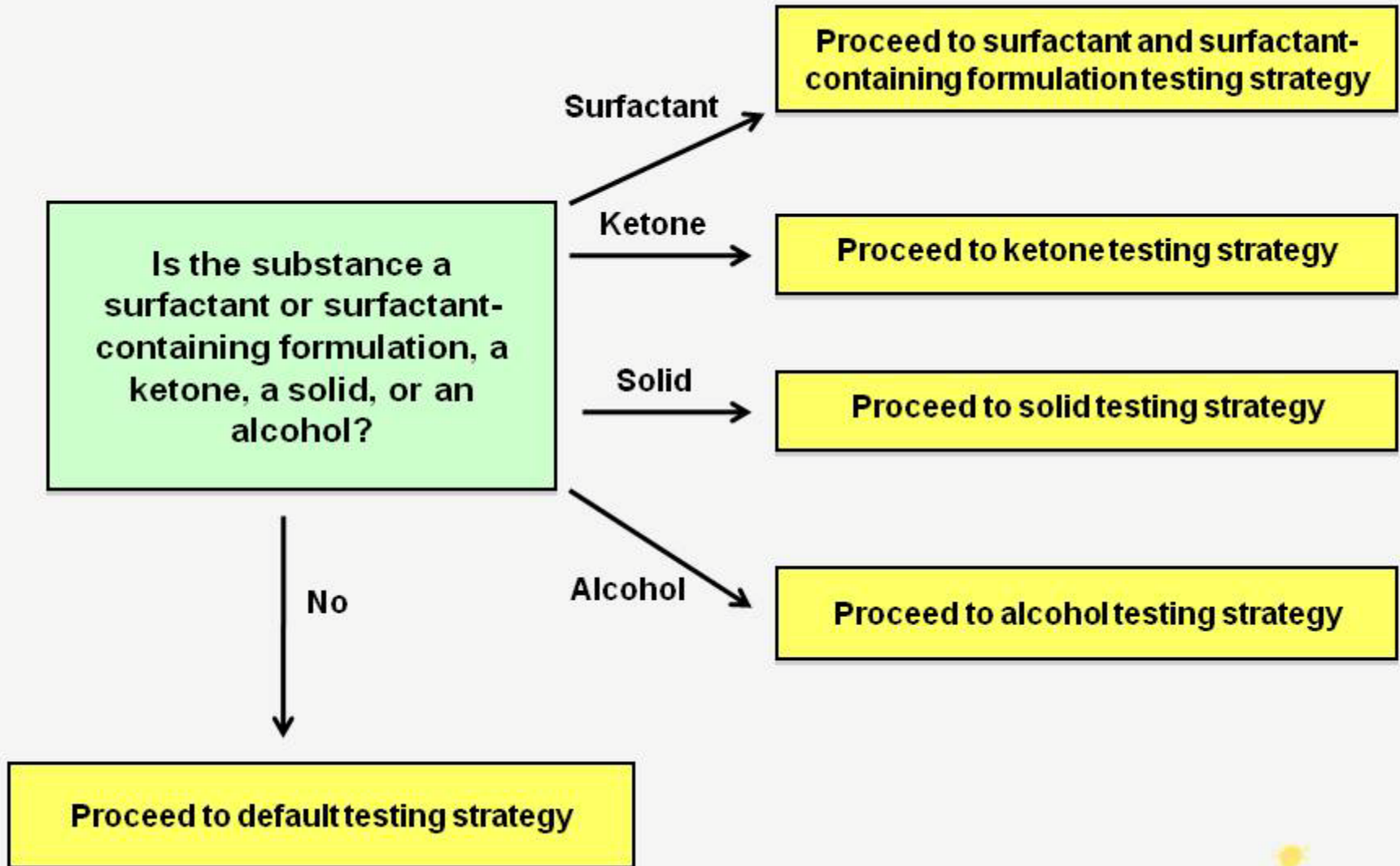

Is the substance water-soluble?

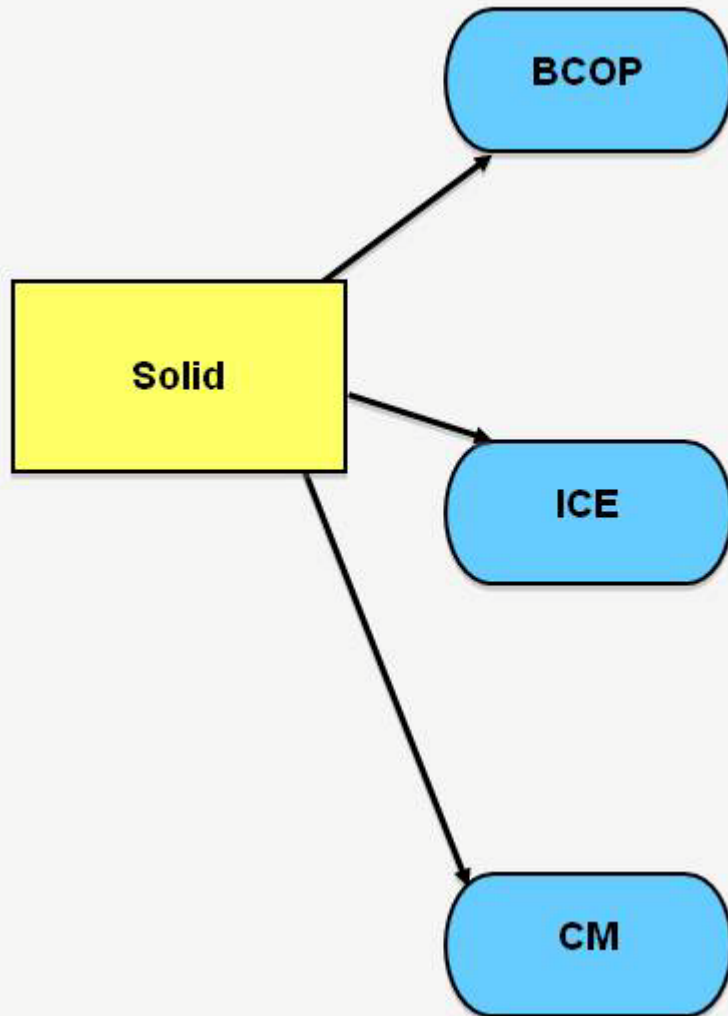

Which test method(s) can you use?

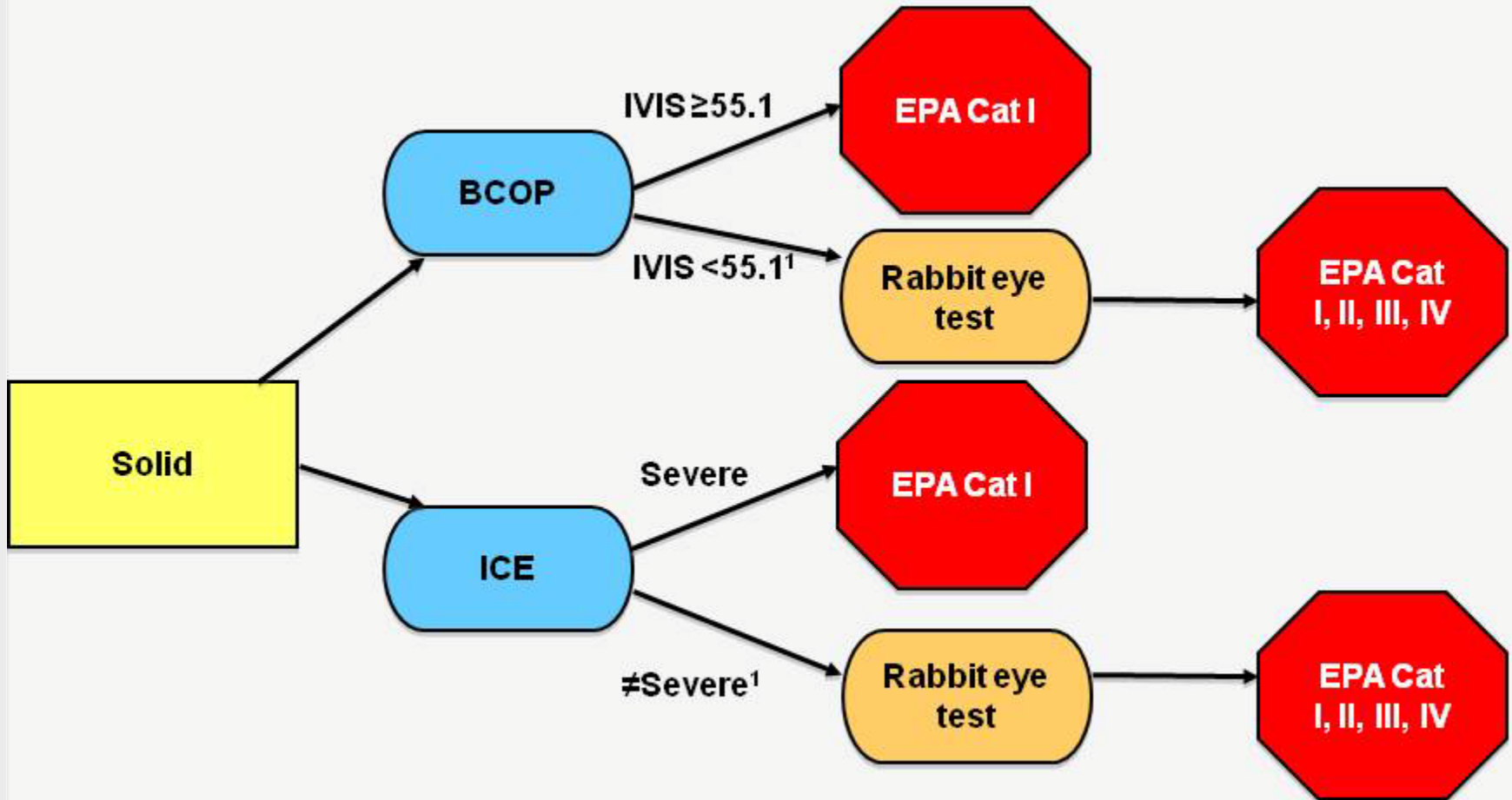

¹Based on high false negative rates, solids are an identified limitation for both ICE (70% [7/10]) and BCOP (50% [5/10]).

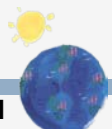

Preparation of BCOP Test Substance (Solid) and Concurrent Controls

- Minimum of three bovine corneas are treated with the test substance
 - 20% (w/v) suspension in 0.9% sodium chloride solution as described for solid nonsurfactant test substances
- Minimum of three bovine corneas are treated with the positive control
 - 20% (w/v) imidazole in 0.9% sodium chloride solution as suggested for solid test substances
- Minimum of three bovine corneas are treated with the solvent/vehicle control
 - 0.9% sodium chloride
- Time of exposure for solids: 4 hours
- Endpoints measured: Corneal opacity and permeability

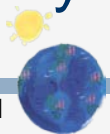

BCOP Concurrent Control Data

- Historical positive control data (20% imidazole) from the testing laboratory:

	Opacity (Opacity _{final} – Opacity _{initial})	Permeability (OD ₄₉₀)	<i>In Vitro</i> Irritancy Score (IVIS)
Mean (n = 125)	76.4	1.768	103.0
SD	18.4	0.488	16.6
CV	24.1%	27.6%	16.2%
Upper and lower limits	39.7 – 113.2	0.792 – 2.745	69.7 – 136.2

- IVIS for 20% imidazole in current study = 128.7 (within two standard deviations of the current historical mean) → test acceptable
- The 0.9% sodium chloride values for opacity and permeability are less than the established upper limits (based on historical data in the testing laboratory) for background opacity and permeability values for corneas treated with 0.9% sodium chloride → test acceptable

BCOP Test Substance Data

Test substance data:

Cornea	Opacity (Opacity _{final} – Opacity _{initial})	Permeability (OD ₄₉₀)
1	54	4.006
2	54	4.708
3	61	5
4	76	4.914
Mean	61.2	4.657

- Using the following equation, calculate an *in vitro* irritancy score (IVIS)
 - $IVIS = \text{mean opacity value} + (15 \times \text{mean OD}_{490} \text{ value})$
 - $IVIS = 61.2 + (15 \times 4.657)$
 - **IVIS = 131.1**

IVIS = 131.1: Can the substance be labeled without further testing?

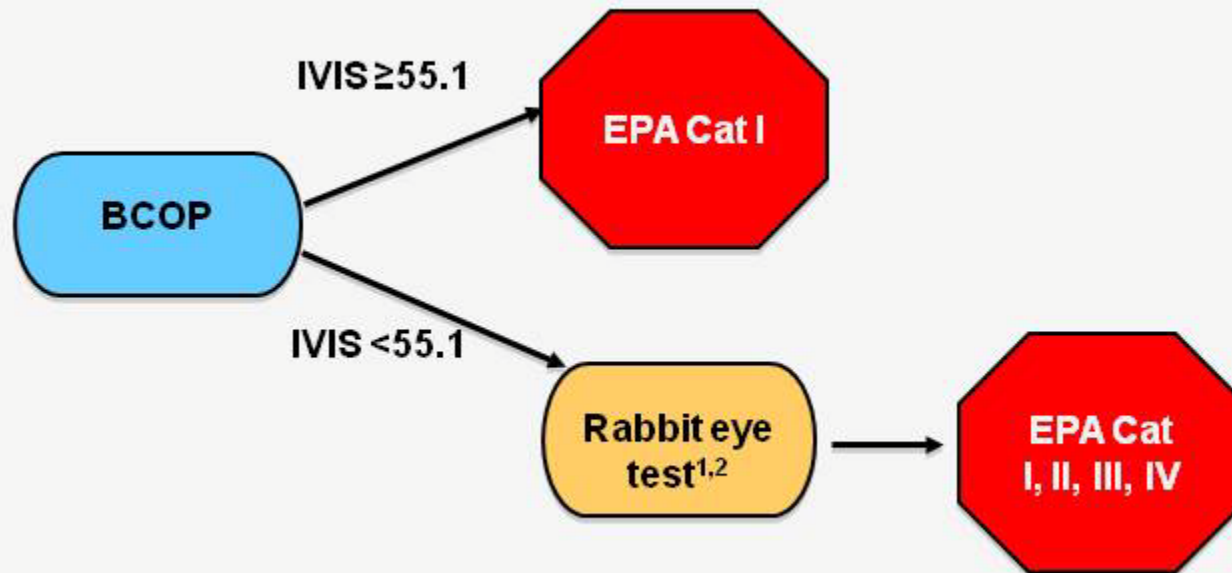

¹ A pain management procedure that includes the routine use of topical anesthetics, systemic analgesics, and humane endpoints should *always* be used when it is determined necessary to conduct the rabbit eye test.

² The rabbit eye test should begin with an initial test using one animal. If the results of this test indicate the substance to be a severe irritant or corrosive to the eyes, further testing should not be performed. If that test does not reveal any corrosive or severe irritant effects, a confirmatory test is conducted with two additional animals (OECD 2002).



Ocular Case Study 1: Summary

- This case study:
 - Emphasizes the tiered-testing strategy to be followed to determine whether a validated and accepted *in vitro* ocular test method should be considered (TG 405; OECD 2002)
 - Highlights that positive results in the BCOP test method can be used to classify, under certain circumstances and with specific limitations, substances as ocular corrosives and severe irritants without further testing (TG 437; OECD 2009)
 - **What if positive control was out of range?**
 - If test is for regulatory use, repeat the study
 - **Would you include it in the range?**
 - Not if you have a reason to exclude it
 - **How many tests make a historical database?**
 - There are various standards – some say 20 over 2 years
 - ICCVAM uses 10 for validation studies
 - **Why not classify as EPA Category II?**
 - BCOP can only be used to classify EPA Category I

Ocular Case Study 2

Ocular Case Study 2

- You have been asked to assess the potential that a surfactant-containing formulation is likely to induce eye injuries.
- You have been given the following limited information:
 - The substance is soluble in water.
 - Human accidental exposure data and rabbit eye test data are not available.
 - No additional information is available.
- You have already determined that a validated and accepted *in vitro* ocular test method should be considered.

Which *in vitro* ocular test method(s) should be considered for testing?

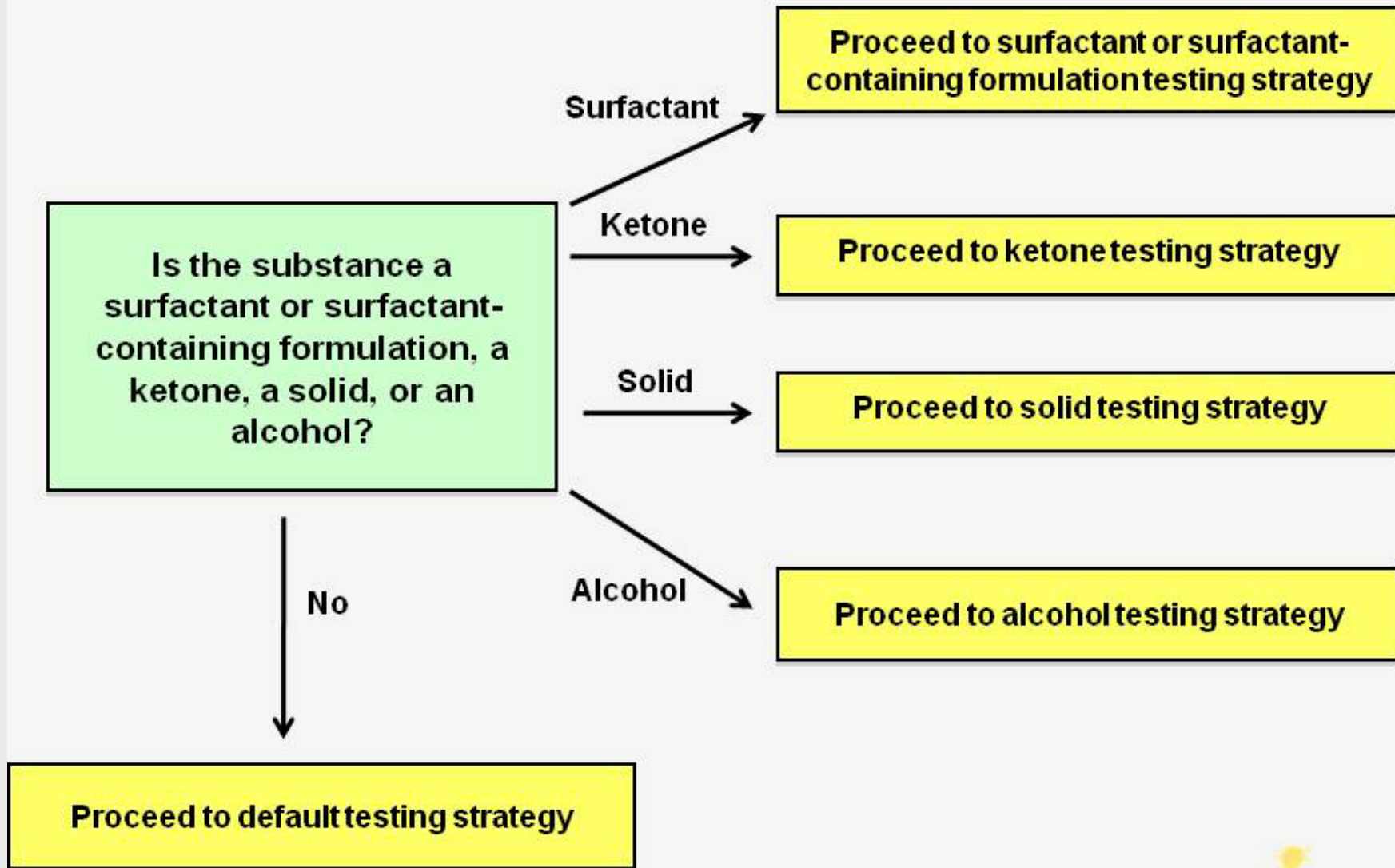

Is the substance water-soluble?

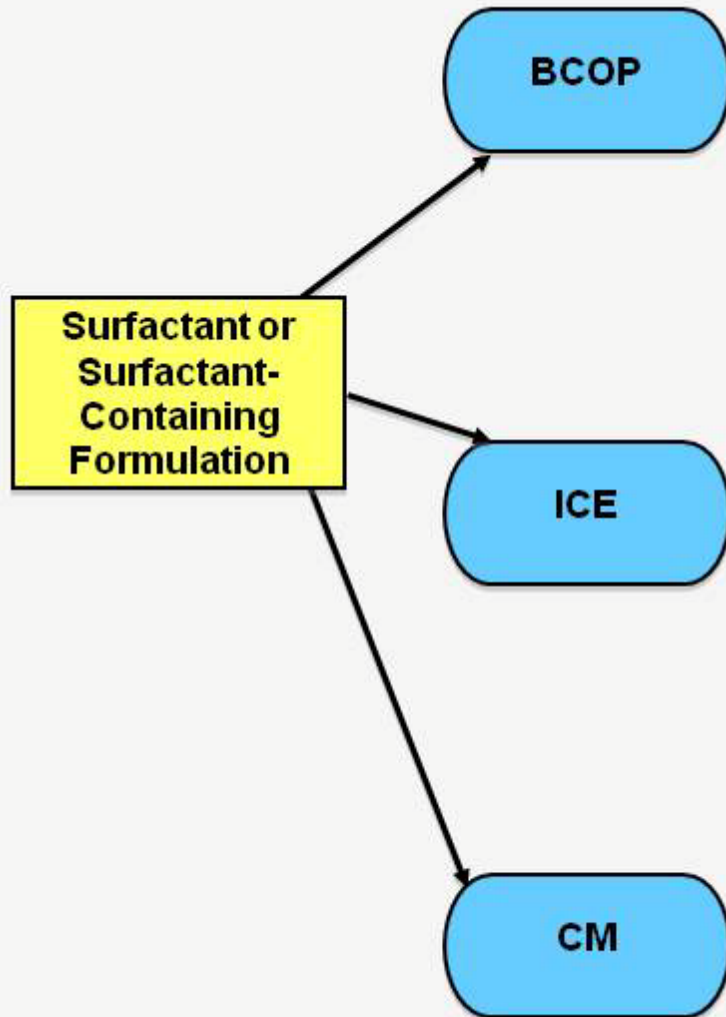

Which test method(s) can you use?

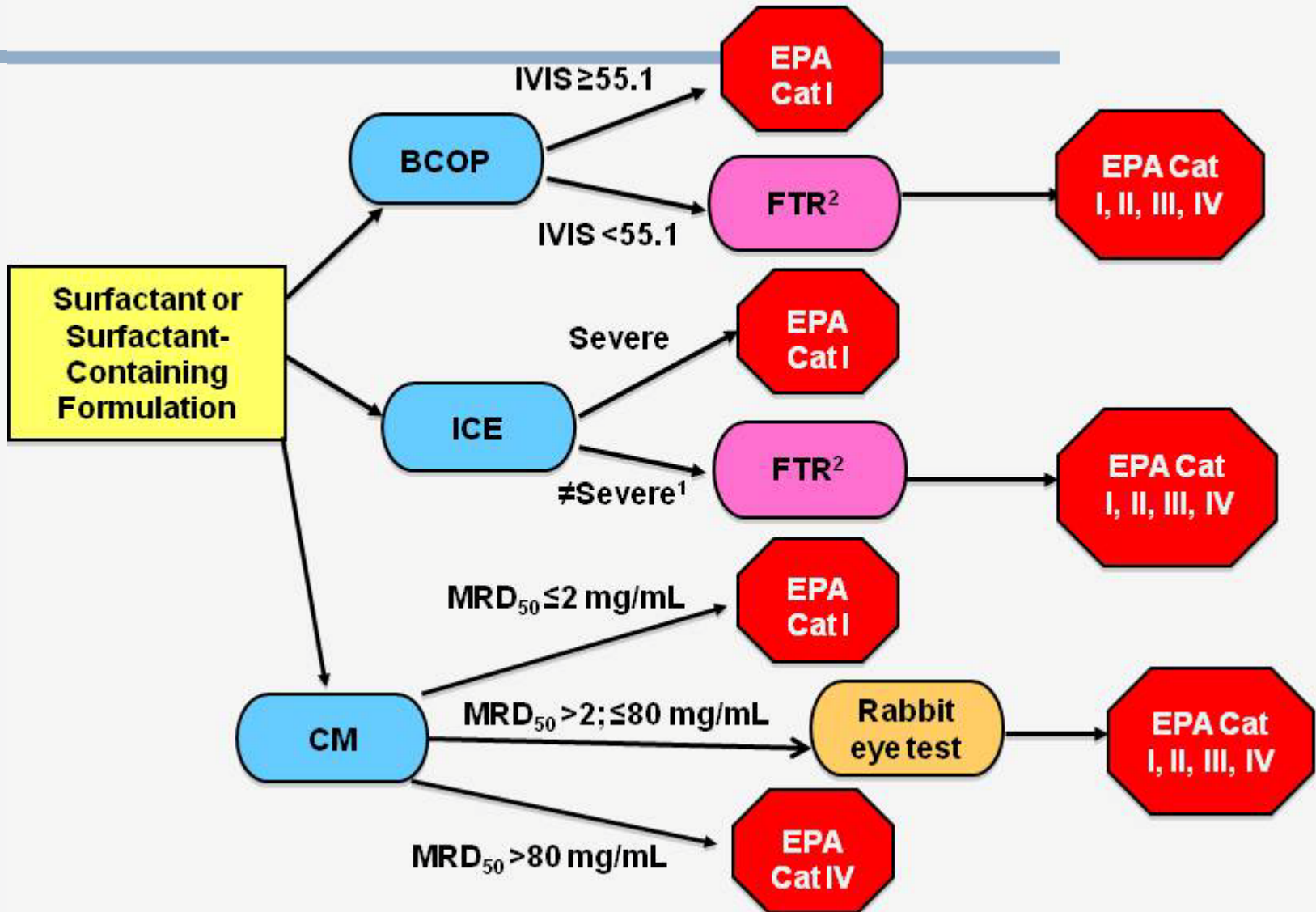

¹Based on the high false negative rate, surfactants are an identified limitation for ICE (57% [4/7]). By comparison, the false negative rate for surfactants with BCOP is 23% (3/13) and with CM is 2% (1/46).

²FTR = Further Testing Required; could be conducted in either CM (EPA Cat IV) or the rabbit eye test (EPA Cat I-IV).

Preparation of CM Test Substance and Concurrent Control

- L929 mouse fibroblast cells are treated with the test substance
 - Seven concentrations (predetermined in the dose range-finding assay)
 - Diluted in low-buffered treatment medium
 - At least two independent runs
- L929 cells are treated with the positive control in each run
 - 10% (w/v) sodium lauryl sulfate (SLS)
- Time of exposure: 13 minutes 30 seconds
- Endpoint measured: Rate of pH change

CM Concurrent Control Data

Historical positive control data (10% SLS) from the testing laboratory:

	MRD ₅₀ (mg/mL) ¹
Mean (n=629)	0.0799
SD	0.011
CV	14.3%

- MRD₅₀ for positive control in current study = 0.0781 mg/mL (within two standard deviations of the current historical mean) → test acceptable

¹MRD₅₀: Metabolic rate decrement of 50%. The concentration of test substance (weight/volume) required to cause 50% inhibition of the basal acidification (metabolic) rate.



CM Test Substance Data (1)

Using the following equation, the CM software calculates the % of control acidification rate for each test substance concentration

$$\% \text{ of control acidification rate} = \frac{\text{acidification rate after exposure to test chemical}}{\text{basal acidification rate}} \times 100$$

- % of control acidification rates are then plotted against the test substance concentrations
 - The test substance concentration that results in a 50% reduction in acidification rate is interpolated from the curve and referred to as the MRD₅₀

CM Test Substance Data (2)

- Test substance data:

	MRD ₅₀ (mg/mL)			
Test Substance	Trial 1	Trial 2	Trial 3	Mean
A	84.40	84.22	84.17	84.26

MRD₅₀ = 84.26 mg/mL: Can the substance be labeled without further testing?

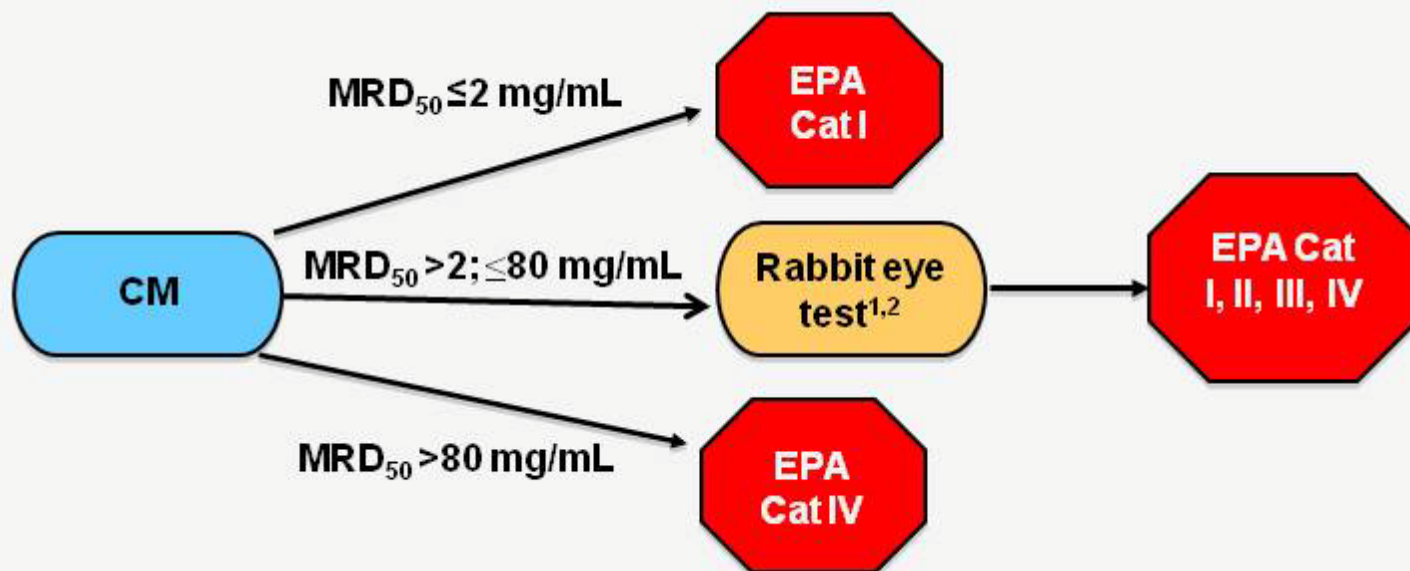

¹A pain management procedure that includes the routine use of topical anesthetics, systemic analgesics, and humane endpoints should *always* be used when it is determined necessary to conduct the rabbit eye test.

² The rabbit eye test should begin with an initial test using one animal. If the results of this test indicate the substance to be a severe irritant or corrosive to the eyes, further testing should not be performed. If that test does not reveal any corrosive or severe irritant effects, a confirmatory test is conducted with two additional animals (OECD 2002).



Ocular Case Study 2: Summary

- This case study:
 - Highlights that negative results in the CM test method can be used to classify water-soluble surfactant chemicals and certain types of surfactant-containing formulations as substances not classified as irritant without further testing (ICCVAM 2010)¹
 - First *in vitro* test method to be recommended by ICCVAM for this testing purpose and as such can further reduce the number of animals used in ocular safety testing
 - Discussion about whether CM was adequate for EPA Category IV classifications because there were no human data for the limited dataset evaluated during validation
 - Some suggested additional testing with other *in vitro* methods
 - Not much incentive for clients to use *in vitro* tests when they eventually have to use the rabbit test anyway
 - If you chose more than one method, how would you decide which result to use?
 - What if variability caused your mean MRD₅₀ to drop slightly below 80?

¹ICCVAM recommendation currently being reviewed by Federal agencies; responses due March 2011.

Ocular Case Study 3

Ocular Case Study 3

- You have been asked to assess the potential that a colorless liquid is likely to induce eye injuries.
- You have been given the following information:
 - The pH of the substance = 7.1
 - The substance is insoluble in water.
 - The molecular weight of the substance = 144.08
 - Human accidental exposure data and rabbit eye test data are not available.
 - The substance is a ketone.
 - No additional information is available.
- You have already determined that a validated and accepted *in vitro* ocular test method should be considered.

Which *in vitro* ocular test method(s) should be considered for testing?

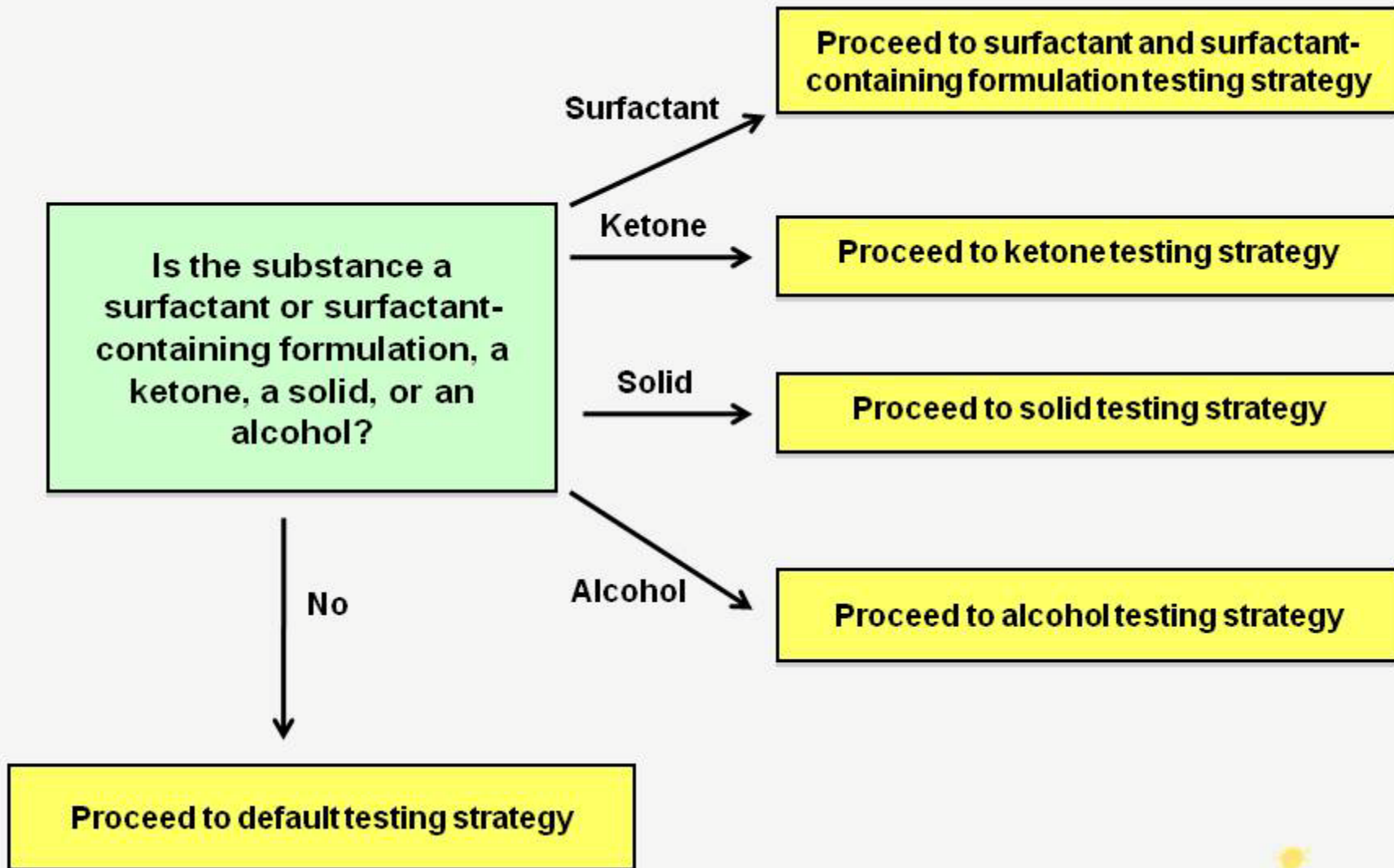

Is the substance water-soluble?

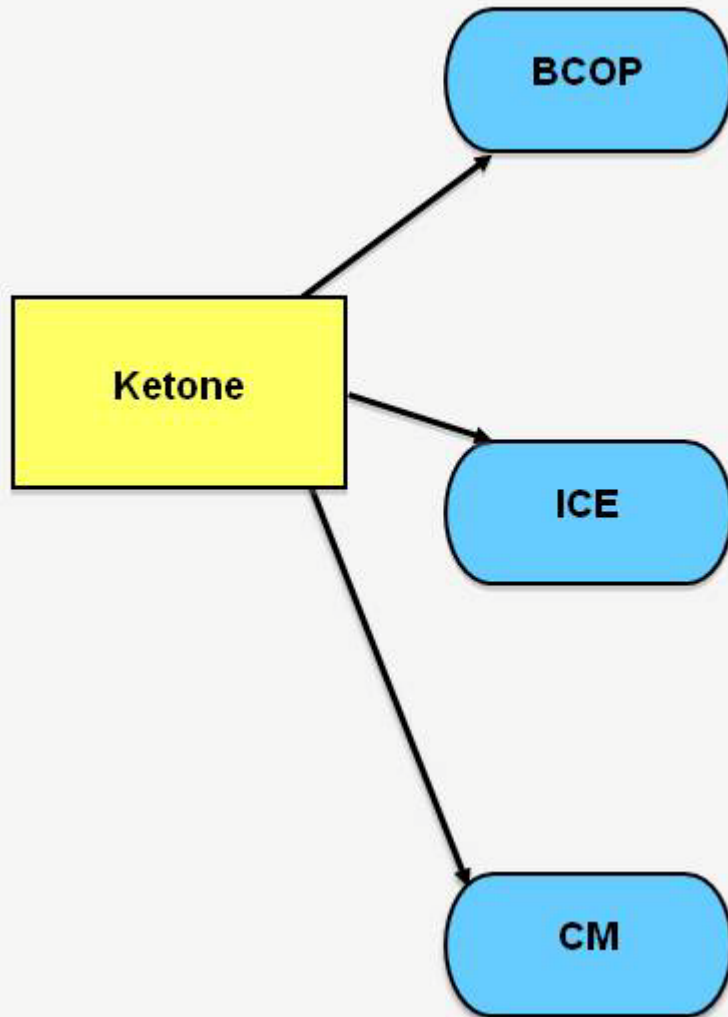

Which test method(s) can you use?

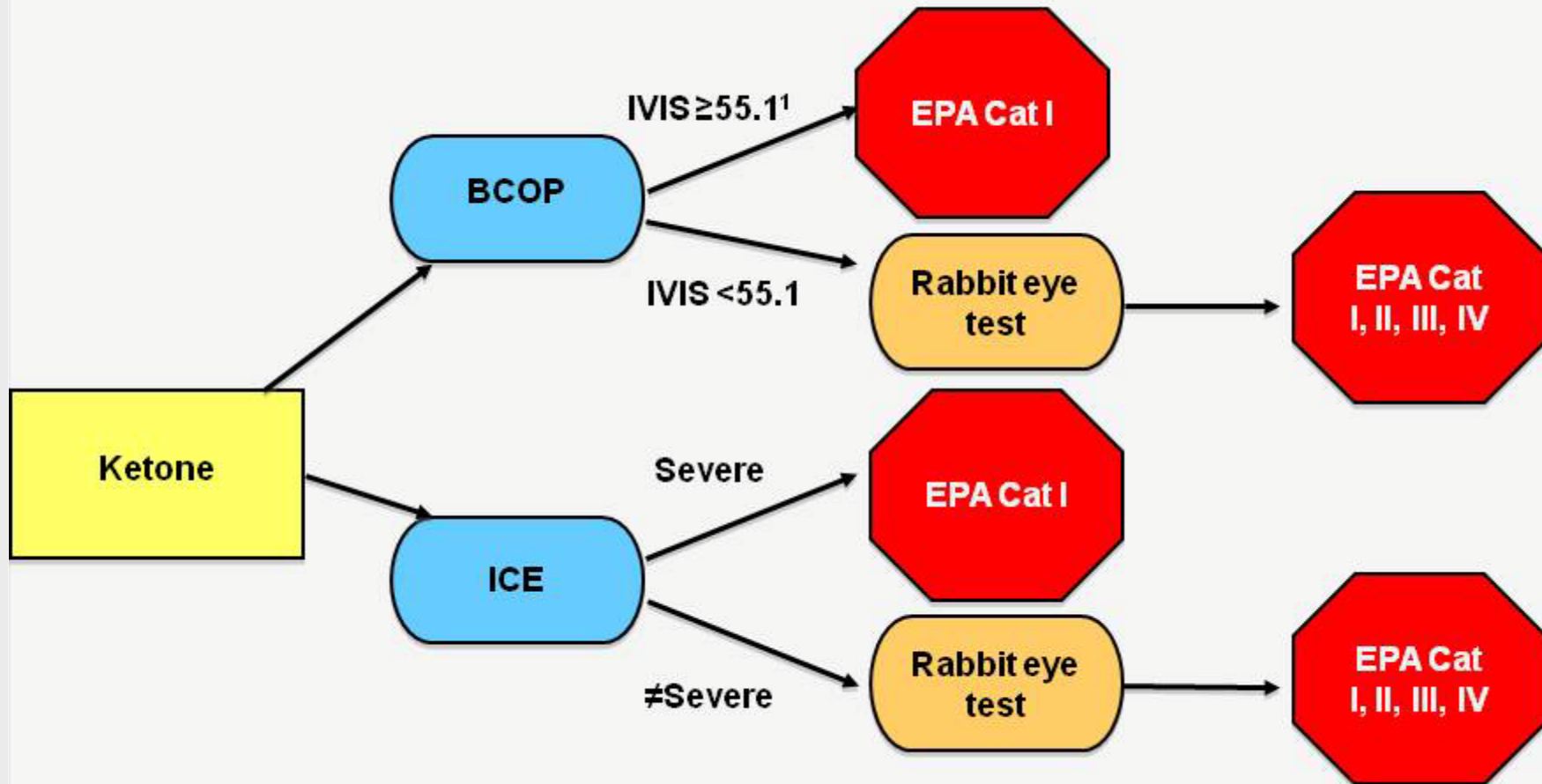

¹Based on the high false positive rate, ketones are an identified limitation for BCOP (40% [4/10]) and should be interpreted cautiously due to the risk of overprediction. By comparison, one of the four ketones in the ICE database was false positive.



Preparation of ICE Test Substance (Liquid) and Concurrent Controls

- Minimum of three eyes are treated with the test substance
 - Undiluted (100%)
- Minimum of three eyes are treated with the positive control
 - 10% acetic acid as suggested for liquid test substances
- Minimum of one eye is treated with the negative control
 - Physiological saline
- Time of exposure: 10 seconds
- Endpoints measured: Corneal opacity, corneal swelling, fluorescein retention, and morphological effects

ICE Concurrent Control Data

Positive control data (10% acetic acid) in current study

	Corneal Opacity (mean) ¹	Corneal Swelling (%; mean) ¹	Fluorescein Retention (mean) ²	Overall <i>In Vitro</i> Irritancy Classification
Score	2.6	31	3	Corrosive/ Severe Irritant

- Overall *in vitro* irritancy classification for positive control = corrosive/severe irritant → test acceptable
- Overall *in vitro* irritancy classification for negative control = nonirritant → test acceptable

¹Highest mean score as observed at any time point (30, 75, 120, 180, and 240 minutes after the post-treatment rinse).

²Mean score for the 30-minute observation time point only.



ICE Test Substance Data

- Test substance data:

	Corneal Opacity (mean) ¹	Corneal Swelling (%; mean) ¹	Fluorescein Retention (mean) ²
Score	0	7	1

- Corneal opacity score = 0

- No opacity

- Corneal swelling = 7%

$$\left(\frac{\text{corneal thickness at time } t - \text{corneal thickness at time } = 0}{\text{corneal thickness at time } = 0} \right) \times 100$$

- Fluorescein retention score = 1

- Single cell staining scattered throughout the treated area of the cornea

¹Highest mean score as observed at any time point (30, 75, 120, 180, and 240 minutes after the post-treatment rinse).

²Mean score for the 30-minute observation time point only.

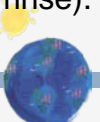

Assign an ICE Class for Each Endpoint

- Based on a predetermined range, the following ICE classes were assigned for each endpoint:

Substance	Corneal Swelling (% , mean)	ICE Class	Corneal Opacity (mean)	ICE Class	Fluorescein Retention (mean)	ICE Class
A	7	II	0	I	1	II

- Resulting combination of ICE classes: 2 x II, 1 x I
- No corneal opacity ≥ 3 at any time point in any eye
- No loosening of the epithelium observed in any eye

Overall *In Vitro* Irritancy Classification Scheme – Can the substance be labeled as a corrosive/severe irritant?

- Resulting combination of ICE classes: 2 x II, 1 x I
- No corneal opacity ≥ 3 at any time point in any eye
- No loosening of the epithelium observed in any eye
- No; Based on these data, the test substance cannot be labeled as a corrosive/severe irritant

Classification	Combinations of the 3 Endpoints
Corrosive/Severe Irritant	3 x IV
	2 x IV, 1 x III
	2 x IV, 1 x II
	2 x IV, 1 x I
	Corneal opacity ≥ 3 at 30 min (in at least 2 eyes)
	Corneal opacity = 4 at any time point (in at least 2 eyes)
	Severe loosening of the epithelium (in at least 1 eye)

Overall *In Vitro* Irritancy Classification ≠ Severe: Can the substance be labeled without further testing?

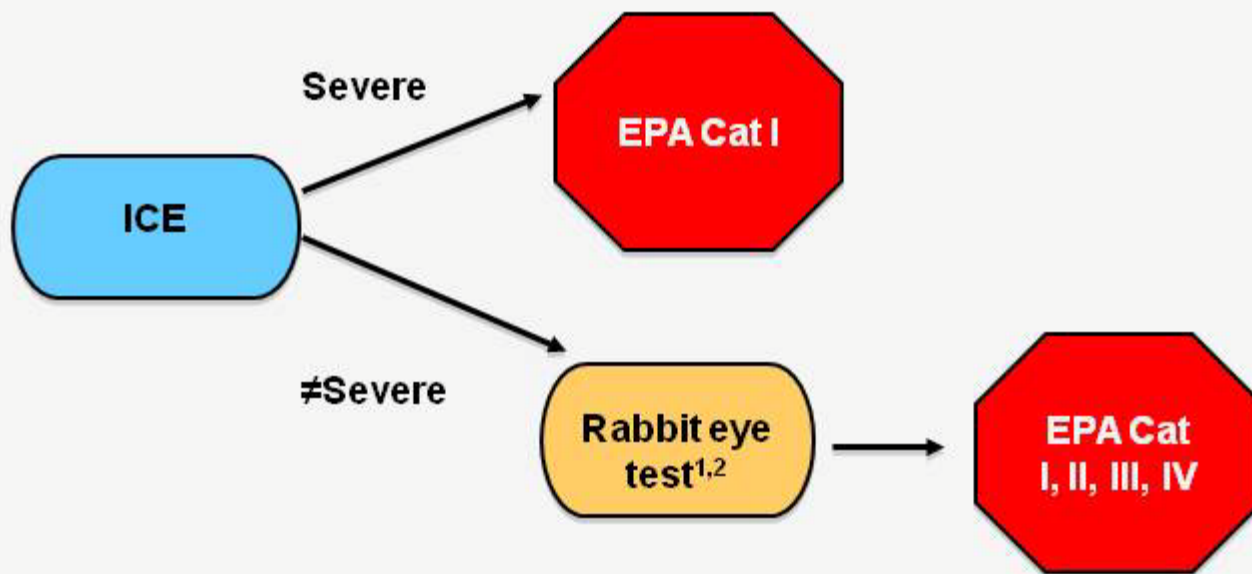

¹ A pain management procedure that includes the routine use of topical anesthetics, systemic analgesics, and humane endpoints should *always* be used when it is determined necessary to conduct the rabbit eye test.

² The rabbit eye test should begin with an initial test using one animal. If the results of this test indicate the substance to be a severe irritant or corrosive to the eyes, further testing should not be performed. If that test does not reveal any corrosive or severe irritant effects, a confirmatory test is conducted with two additional animals (OECD 2002).



What pain management procedures do you use prior to test substance application?

- Pretreatment with a topical anesthetics and a systemic analgesics
 - 60 minutes pre-test substance application (TSA):
 - Buprenorphine 0.01 mg/kg by subcutaneous injection (SC) to provide a therapeutic level of systemic analgesia
 - 5 minutes pre-TSA:
 - 1-2 drops of a topical ocular anesthetic (e.g., 0.5% proparacaine hydrochloride) are applied to each eye
 - The eye of each animal that is not treated with the test substance, but which is treated with topical anesthetics, will serve as a control
- Application of test substance

At 1 hour post-TSA, what ocular lesions and clinical signs are observed?

- The following ocular lesion scores are obtained and recorded:

Lesion	Corneal Opacity	Iritis	Conjunctival Redness	Conjunctival Chemosis
Score ¹	1	1	3	2

- No clinical signs of pain and/or distress are observed
 - For example,
 - No repeated pawing or rubbing of the eye
 - No excessive blinking
 - No excessive tearing

¹ For the EPA classification system, the following scores are considered positive: corneal opacity or iritis ≥ 1 or conjunctival redness or conjunctival chemosis ≥ 2 . Therefore, corneal opacity and iritis scores of 0 or conjunctival redness and conjunctival chemosis scores ≤ 1 are considered cleared.

At 8 hour post-TSA, what pain management procedures do you use?

- Post-treatment with a systemic analgesic and a nonsteroidal anti-inflammatory drug
 - Buprenorphine 0.01 mg/kg by subcutaneous injection (SC), in conjunction with meloxicam 0.5 mg/kg SC

At 24 hours post-TSA, what ocular lesions and clinical signs are observed?

- The following ocular lesion scores are obtained and recorded:

Lesion	Corneal Opacity	Iritis	Conjunctival Redness	Conjunctival Chemosis
Score ¹	2	1	3	2

- No clinical signs of pain and/or distress are observed
- What pain management procedures do you use?
 - Based on the presence of ocular lesions, continue with buprenorphine 0.01 mg/kg by subcutaneous injection (SC) every 12 hours and meloxicam 0.5 mg/kg SC every 24 hours until the lesions clear

¹ For the EPA classification system, the following scores are considered positive: corneal opacity or iritis ≥ 1 or conjunctival redness or conjunctival chemosis ≥ 2 . Therefore, corneal opacity and iritis scores of 0 or conjunctival redness and conjunctival chemosis scores ≤ 1 are considered cleared.

Rabbit Eye Test Termination and Result

- Daily observations are performed and recorded
- Positive ocular lesion scores are obtained through day 7
- The following ocular lesion scores are obtained and recorded on day 8:

Lesion	Corneal Opacity	Iritis	Conjunctival Redness	Conjunctival Chemosis
Score ¹	0	0	1	0

- Based on these results, the test substance is labeled as EPA Category II

¹ For the EPA classification system, the following scores are considered positive: corneal opacity or iritis ≥ 1 or conjunctival redness or conjunctival chemosis ≥ 2 . Therefore, corneal opacity and iritis scores of 0 or conjunctival redness and conjunctival chemosis scores ≤ 1 are considered cleared.

Ocular Case Study 3: Summary

- This case study:
 - Highlights that positive results in the ICE test method can be used to classify, under certain circumstances and with specific limitations, substances as ocular corrosives and severe irritants without further testing (TG 438; OECD 2009)
 - Emphasizes the pain management procedures that include the routine use of topical anesthetics and systemic analgesics that should *a/ways* be used when it is determined necessary to conduct the rabbit eye test (ICCVAM 2010)¹
 - Indicates that ketones are an identified limitation for the BCOP test method based on the high false positive rate (40% [4/10]) (ICCVAM 2006)
 - **Note that these animals would be USDA Column D (Pain or Distress Relieved By Appropriate Measures)**

¹ICCVAM recommendation currently being reviewed by Federal agencies; responses due March 2011.



Ocular Case Study 4

Ocular Case Study 4

- You have been asked to assess the potential that a colorless liquid is likely to induce eye injuries.
- You have been given the following information:
 - The pH of the substance = 7
 - The substance is soluble in water.
 - The molecular weight of the substance = 74.1
 - The substance is not a surfactant.
 - Human accidental exposure data and rabbit eye test data are not available.
 - The substance is an alcohol.
 - No additional information is available.
- You have already determined that a validated and accepted *in vitro* ocular test method should be considered.

Which *in vitro* ocular test method(s) should be considered for testing?

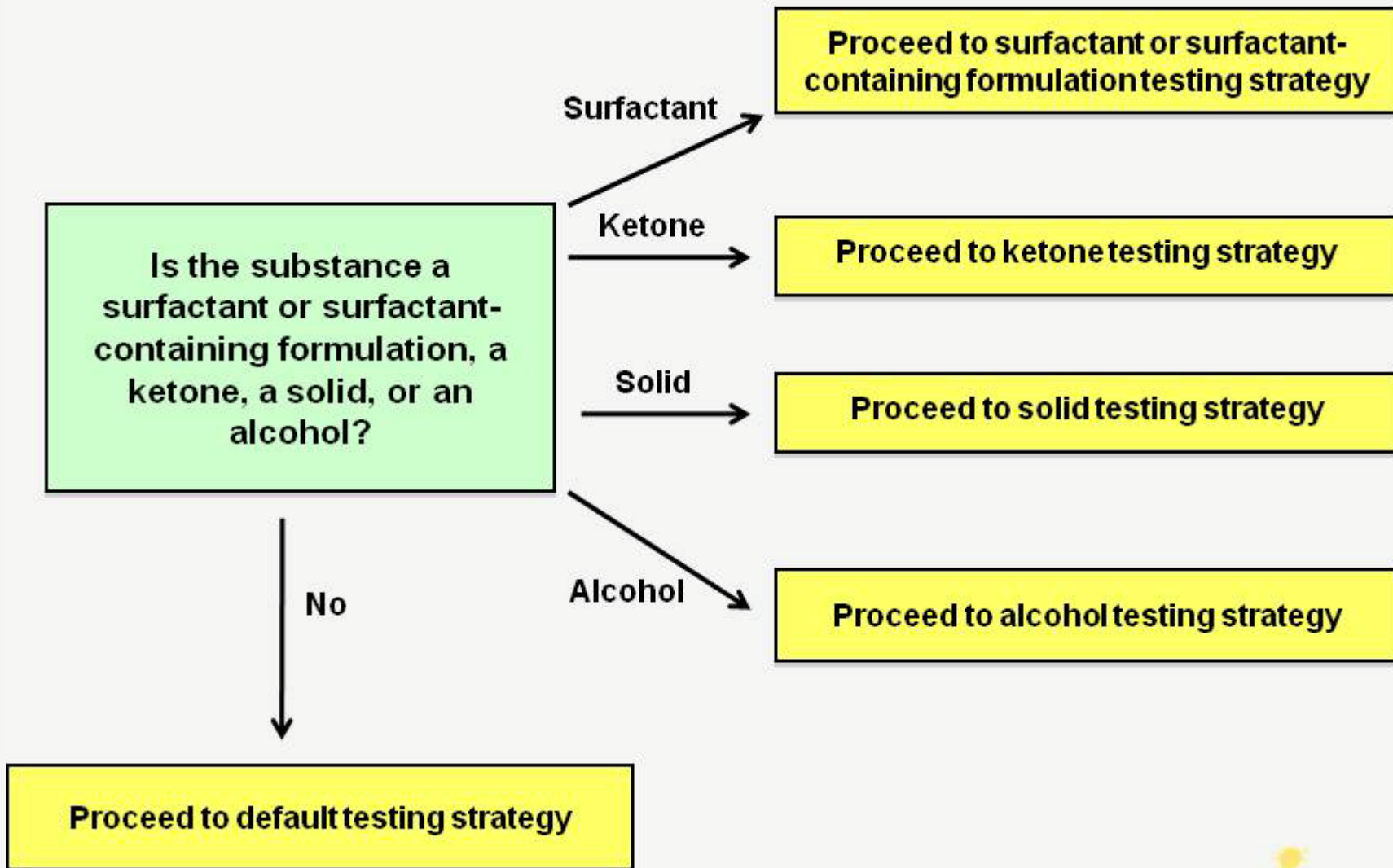

Is the substance water-soluble?

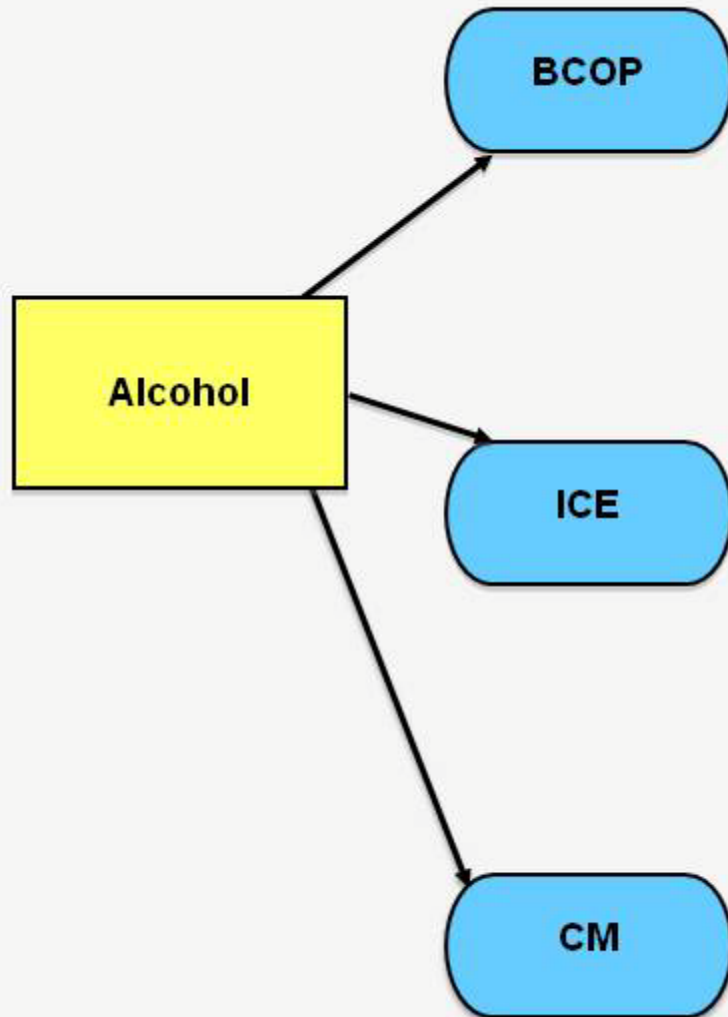

Which test method(s) can you use?

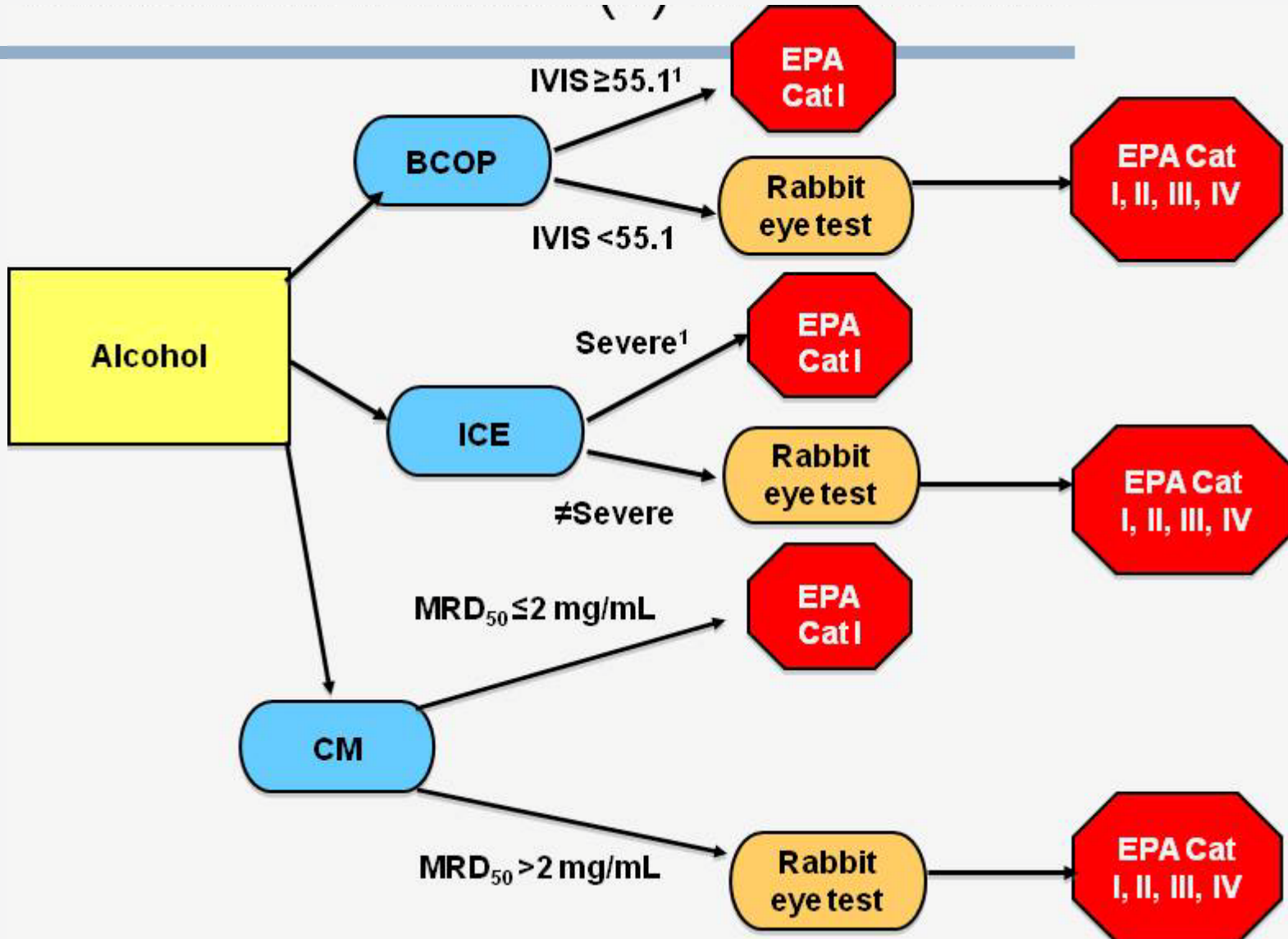

¹Based on high false positive rates, alcohols are an identified limitation for both BCOP (56% [9/16]) and ICE (50% [5/10]) and should be interpreted cautiously due to the risk of overprediction. By comparison, none of the alcohols (0/4) in the CM database were false positive.

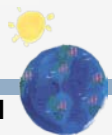

CM Test Substance Data

- Preparation of test substance and positive control as outlined in previous CM case study
- MRD_{50} for positive control within two standard deviations of the current historical mean → test acceptable
- Test substance data:

	MRD_{50} (mg/mL) ¹			
Test Substance	Trial 1	Trial 2	Trial 3	Mean
A	1.71	1.67	1.70	1.69

¹ MRD_{50} : Metabolic rate decrement of 50%. The concentration of test substance (weight/volume) required to cause 50% inhibition of the basal acidification rate.

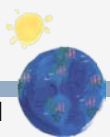

MRD₅₀ = 1.69 mg/mL: Can the substance be labeled without further testing?

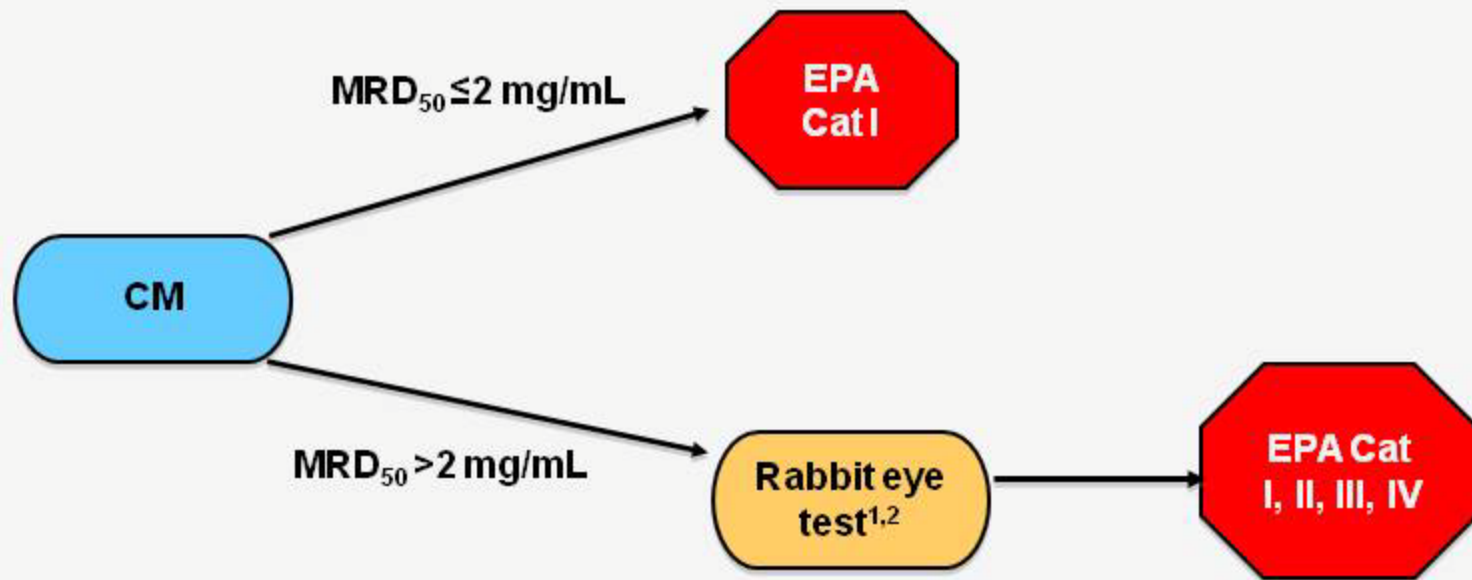

¹A pain management procedure that includes the routine use of topical anesthetics, systemic analgesics, and humane endpoints should *always* be used when it is determined necessary to conduct the rabbit eye test.

² The rabbit eye test should begin with an initial test using one animal. If the results of this test indicate the substance to be a severe irritant or corrosive to the eyes, further testing should not be performed. If that test does not reveal any corrosive or severe irritant effects, a confirmatory test is conducted with two additional animals (OECD 2002).



Ocular Case Study 4: Summary

- This case study:
 - Highlights that positive results in the CM test method can be used to classify water-soluble surfactants, surfactant-containing formulations, and **nonsurfactants** as ocular corrosives and severe irritants without further testing (ICCVAM 2010)¹
 - Indicates that alcohols are an identified limitation for both the BCOP (56% [9/16]) and ICE (50% [5/10]) test methods based on the high false positive rate (ICCVAM 2006)

¹ICCVAM recommendation currently being reviewed by Federal agencies; responses due March 2011.

